

**ACHI**® IR-PRO-SC  
www.easyBGA.com



## **BGA Rework Station**

### **User Manual**

**Beijing TECHNICAL CO.,Ltd.**

- **Brief introduction to company**
- **Safety Instrouctions**
- I. Electric Safety**
- II. Operation Safety**
- III. The operation and conservation condition of products**
- **Our contact information**
- **product guarantee and so on**
- **The parameters of **IR-PRO-SC** BGA Rework Station**
- **hardware description and Self-help install**
- **Set Bottom Temperature Controller**
- **Programmer/Controller General Description**
- **BGA Rework operation steps**
- **Prompt**

## Brief introduction to company

Beijing TECHNICAL Science and Technology Co.,Ltd. is a manufacturing enterprise specializes in BGA manual Reworks equipment research,development and production . **ACHI/亚琪®** is our company's registered brand.Based on the principles of producing high-quality and cost-effective welding equipment,our company has developed and produced a number of BGA Rework Stations,such as **IR-3、IR3000 、IR6000、HR-PRO** etc.,and has been recognized by the majority of users in practice.So far,our users have been involved in scientific research units,computer maintenance and repair of medical equipment,communications equipment maintenance,video game maintenance, training teaching, and other fields.

We also produce and operate some assistant and materials of manual BGA welding,such as customized BGA Reballing Template,solder ball, Flux,etc.,to help users streamline operation,improve the success rate of welding,and reduce welding costs.We also can undertake single or small quantities BGA welding business,welcome users to contact us.

In the future,our company will continue serving users with sophisticated products,reasonable price,high quality,and continuously innovating and upgrading product structure and performance according to market,for meeting the developing needs of our users,and providing the users with systemic,comprehensive and thoughtful services.

## Safety Instructions

### I .Electrical safety

- **Make sure the supply power voltage accord with the standards----220V-250V/50hz alternating current before installing.**
- **To avoid possible electric shock caused serious damage, please disconnect the power cord from the outlet temporary before moving machines .**
- **If the machine damages,please contact us for maintenance.If the damage caused by the users when they dismantle or repair independently,they should take on the loss by themselves.**

### II . Operating safety

- **Please carefully read the relevant information provided by the manual before starting using this product .**
- **Make sure the power cord has been properly connected properly before using the products.**
- **Installed the equipment in stable work platform to use,where the air mobility should be small as possible.Avoid it closing to air conditioners,fans and the other outlet.**
- **In case of electrical short-circuit,avoid the products contacting with water.**
- **Forbid using this equipment in flammable and explosive substances.**
- **The operators' hands or other parts of the body should maintain a safe distance from the heater.Forbid touching the heater to avoid scalding.**
- **If you have any technical questions or suggestions in the course of using this product,please contact with our technology department.We will try our best to solve.**

### III.Environmental requirements of operation and conservation

#### 1. Operation environment of products

- **Operation temperature:15 ~ 45 °C**
- **Operation humidity:5% to 95%, non-condensing**
- **Products should be kept in the air mobility of a smaller environment under the welding operation.**

#### 2.Conservation environment of products

- **Storage temperature:-20 ~ 70 °C**
- **Storage humidity: 5% to 95%, non-condensing**

## Contact us

**Add: Room 8009,  
1 Xicaochang Road  
Haidian District  
Beijing 100080  
The People's Republic Of China**

**Sales Support: 86-10-82853468 (Chinese Speaking)**

**Technology Support: 86-10-82851031(Chinese Speaking)**

**QQ: 448764790 759577566      MSN: [easybga@gmail.com](mailto:easybga@gmail.com)**

**URL.: <http://www.EasyBGA.com>**

### product guarantee and so on

#### Service Statement:

- Enjoy warranty maintenance service for three years,in which the service in the first year is free.And the transport costs arise from maintenance should be paid by the buyers since purchased..
- Only the actual cost of spare parts should be paid from the beginning of the second year(the 13th month)to the end of the third year (the 36th month) since purchased. Please call to ask the specific prices of spare parts.And the transport costs arise from maintenance should be paid by buyers.
- Each product corresponds to the only serial number,the serial number bar code,the warranty certificate ,affixed the fixed position the machinery, of
- Please send the product to the Beijing TECHNICAL CO., if fault happen.
- 



If the following situations occurred,the users will not be entitled to free warranty service,then the maintenance,the cost of materials and the man-hour will be charged.

So to ensure your rights, please read the following note carefully:

- No serial number bar code or damaged serial number bar code.
- Cause damage for not use,keep and storage as the manual.
- Cause internal and external appearance damage by modify or outside force.
- Product was deformed or lost components.
- Change product components without our authorization for maintenance.
- Beyond the warranty period of our promises..
- Product damage were caused by irresistible external factors(such as natural factors, earthquakes,lightning strikes,etc.)

**Note: Do not disassemble it by yourself,it may cause the invalidation of product guarantee. . We reserve the final identification right of the product fault.**

## The parameters of IR-PRO BGA Rework Station

<b>Basic Parameters</b>	
Heating	Upper Dark IR / Bottom IR
Dimension	L 475mm×W480mm×H420 mm
Weight	27kg
Total weight	About 29 kg, vary with the differen need of the users
<b>Electrical Parameters</b>	
Power	220V AC
Upper Heating	Dark IR
Size of Upper heating	80mm×80mm
Consumption of upper heating	400W
Bottom Heating	IR
Size of Bottom heating	260 mm×245 mm
Consumption of Bottom heating	2000W
General power	2500W
<b>Temperature Control</b>	
Control mode of Upper	PLC programmable logic controller, precision ± 0.5%, Alarm
Control mode of Bottom	Independent temperature control, high-precision closed-loop control, precision ± 0.5%, NO Alarm
<b>Rework Function</b>	
SMD	Suit for welding,remove or repair packaged devices such as BGA,PBGA,CSP,multi-layer substrates, EMI metallic shield product and solder/lead free Rework 、welding
Size of applicable chips	≤70mm×70 mm
Size of applicable PCB	≤400mm×305 mm

## Hardware description

**ACHI® IR-PRO-SC** BGA Rework Station is composed of upper part of Heating Components / Bottom Preheat Module / PCB Table / Temperature Control Parts ! Temperature control Table is control the upper and lower heating ,Can Simultaneously heated or First preheat ,then the upper part of heating.



1. Upper Heater
2. X-axis Regulator
3. LED Auxiliary Lighting
4. Y-axis Lifting Regulator
5. Bottom Heater (Pre-Heater)
6. PCB Table and locking handle seat
7. Cooling Fan
8. Start button
9. Emergency Stop button
10. Cooling switch
11. Lighting switch
12. Upper Fan switch
13. Bottom Temperature Controller
14. Upper Programmable Temperature Controller

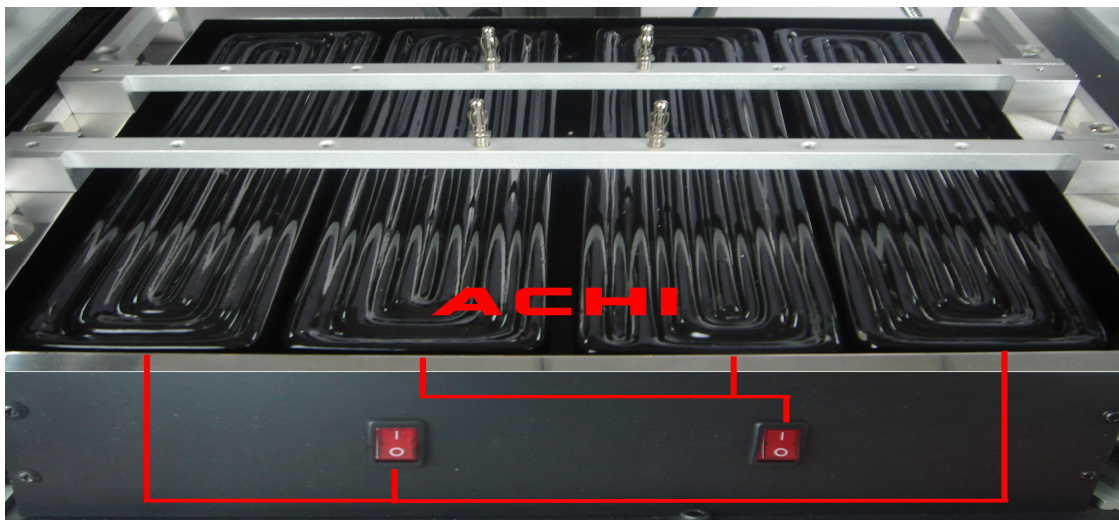
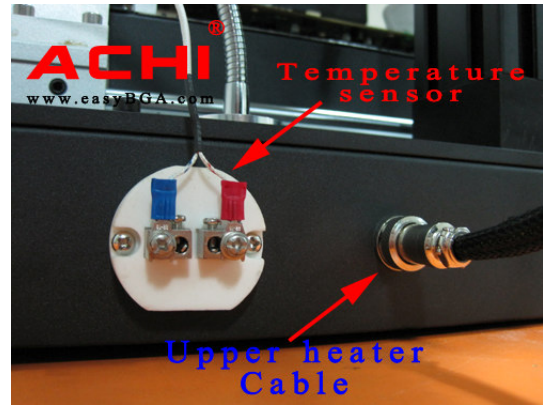

switch selector for Bottom Heater Module



PCB Table



Fixed pole for Shaped Board



## Set Bottom Temperature Controller

**PV:** Display window of actual temperature.

**SV:** Display window of setting temperature.



Press the **SET** button of Bottom temperature control instrumentation for 1 seconds, then the **PV** window to show **SU**.



The **SV** window to show current setting temperature, And the adjustable number flashes. Press key **^** **v** to adjust temperature,, Press key **<** to modify the value.



After the setted , Press the **SET** button for 1 seconds, save the current temp.



## Programmer/Controller General Description

The programmable controller contains an in-built setpoint generator in addition to the controller function. This setpoint generator can produce a temperature/time profile with 10\*16 segments (0~9, 10 Sets of Curves). When the program is running, the current setpoint from the setpoint generator is fed to the control algorithm. The current setpoint is continuously shown on the lower display.

The sixteen segments are defined in the order: Ramp 1, Dwell period 1, Ramp 2, Dwell period 2..., and are executed in succession.

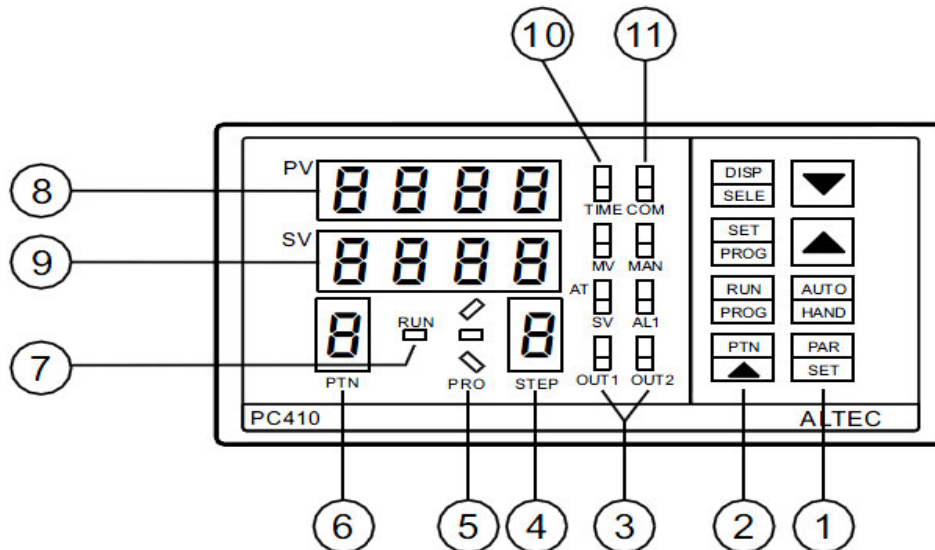

S.N.	Item	Functions
①		Parameters setting key
		(Up key) Increase value
		(Down key) Decrease value
②		Selects the program pattern number
		Starts/hold the program, changes the mode from fixed value control to program control
		Program parameters setup
		Changes the indication on SV/MV/TIME display
③	OUNT	Output indicator
④	STEP	Indicates the step number of program
⑤	PRO	(Program monitor indicator) During program control, ‘/’ is lit when the PV is rising During program control, ‘-’ is lit when the PV is constant During program control, ‘\’ is lit when the PV is falling
⑥	PTN	(Pattern number display) Indicates the pattern number ‘0~9’
⑦	RUN	(Program control runing indicator)

		<b>The LED indicator is lit during program control</b>
⑧	<b>PV</b>	<b>(PV Display) Indicates the Process/Measured value</b>
⑨	<b>SV</b>	<b>It is lit when the Setting Value(SV) is being displayed on the lower display</b>
⑩	<b>TIME MV SV</b>	<b>(SV/MV/TIME display) It indicates the Setting Value(SV), Manipulating Value(MV), or Time(TIME) (The display content can be changed by the 'DISP/SELECT' key)</b>
⑪	<b>AL1</b>	<b>It is lit when the Alarm1 output is 'ON'</b>
	<b>COM</b>	<b>(Communication indicator) It flashes when the controller is in active communication with a host computer</b>

### ● Program Parameters Setting

#### Ramp Rate1: $r_i$

A ramp consists of a slope(linear gradient) and a target setpoint. The control setpoint increases or decreases at a linear ramp rate from the actual measured value until a specified target setpoint is reached. The relative positions of the actual measured value and the target setpoint determine whether the slope of the ramp is positive or negative. Parameters R1, R2, R3... express the ramping rate in unites per minute(0.01~99.99), parameters L1, L2, L3... the appropriate target setpoint in display units.

If R1 = END, the program will be ended when the program runs to the slope.

#### Target Setpoint 1: $U_i$

The target value to which the setpoint ramps when the programmer has been placed into RVN.

#### Dwell period 1:

In a Dwell period, the target setpoint, which has been attained, remains unchanged for a fixed period. All the dwell periods are defined by their duration in minutes with parameters D1, D2, D3...(0~9999). When the program is running, these parameter display the time remaining in the active dwell period. If the parameter equals zero, the dwell period is skipped.

When the controller runs in the **PV** displaying status:

- 1). Select the target program pattern number with the **PTN/** key.
- 2). press **SET/PROG** key, the first program parameter appears in the upper display. The value associated with this parameter will be shown in the lower display.
- 3). Use **▲** and **▼** key to modify the value.
- 4). Press the **PAR/SET** key, the next parameter appears. At the same time, the modification has been saved in the memory. Use **▲** and **▼** key to modify the value.

Repeat this procedure till all the parameters are set. Or if there is no key operation within 16 seconds, the menu times out automatically.

### Program Parameter List

S.N.	Mnemonic	Parameter	Adjustable Range
1	r1	Ramp Rate 1	1
2	l1	Target Setpoint 1	0~230、End
3	d1	Dwell Time 1	0~9999sec
4	r2	Ramp Rate 2	1
5	l2	Target Setpoint 2	0~230、End
6	d2	Dwell Time 2	0~9999sec
...	...	...	...
	Hb		230

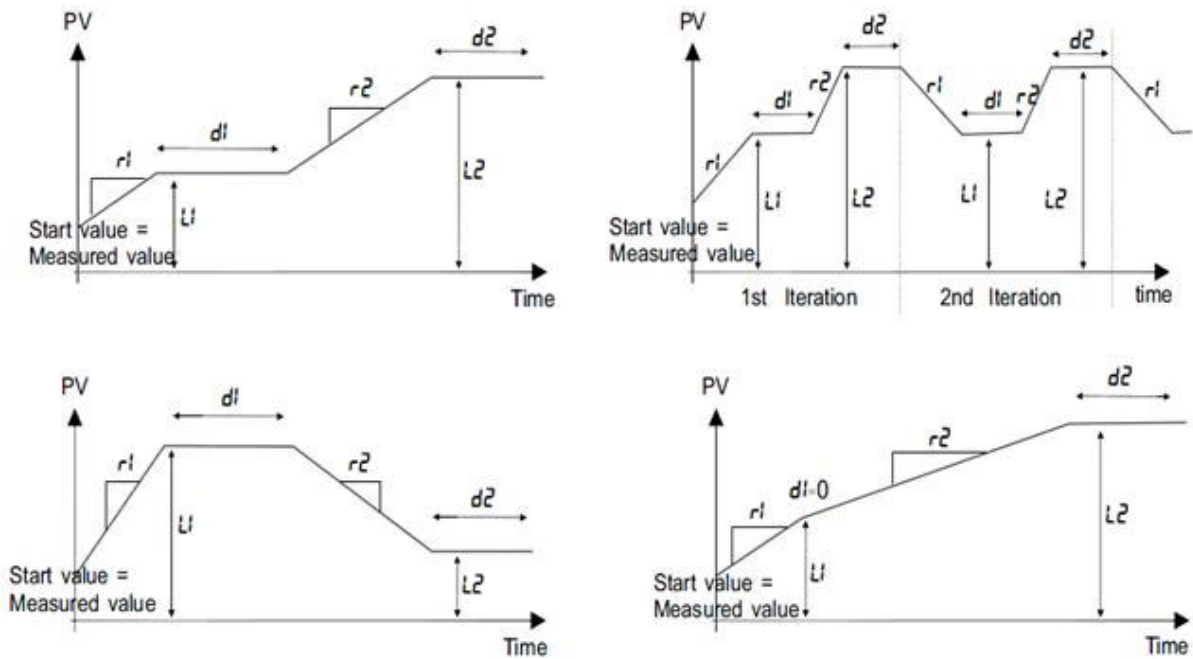

Program Examples

### Rework Operation Steps

#### 1、Be all set

##### ① Fixed motherboard



##### ② Shift sensor , sensor press close to BGA chip.

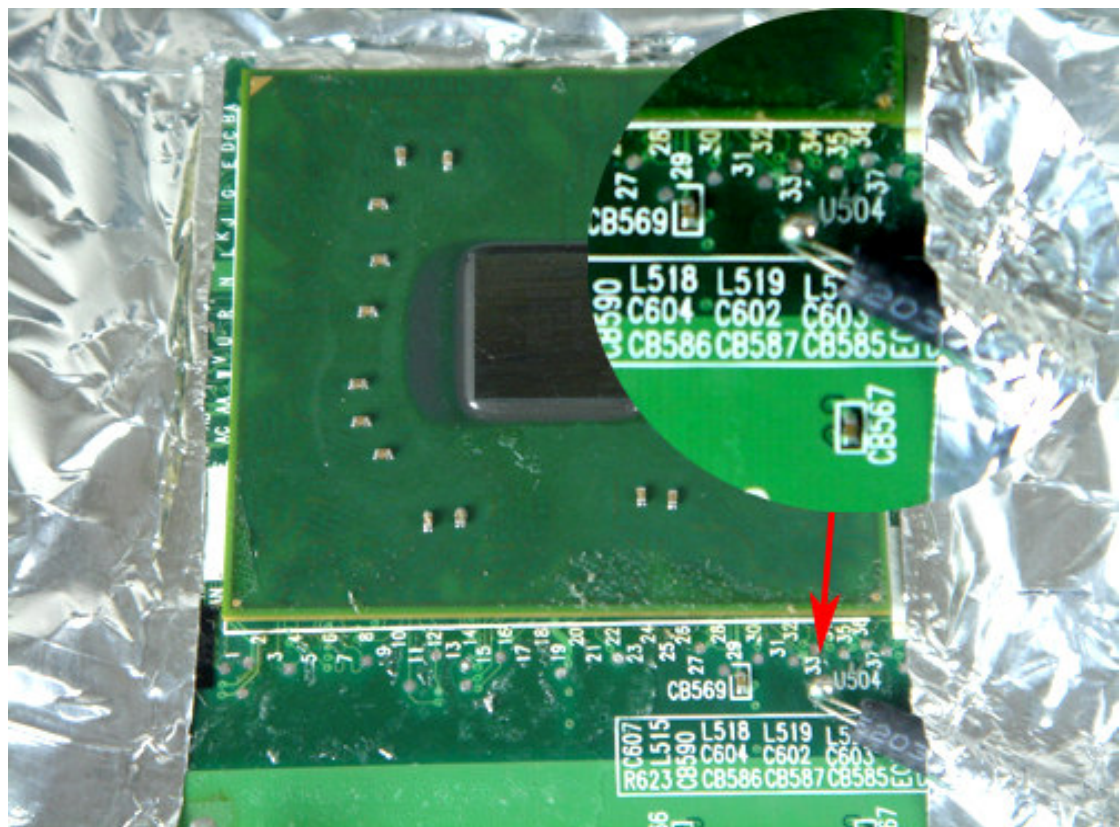

##### ③ Adjust the height of heating head with adjustment knob (Prompt: BGA chip in the middle of heating head , heating head away from BGA chip≥2CM.)



## 2、Start heating

- Select the appropriate temperature program segment,



- then press the start switch. In the operation can press the Emergency stop switch, stop operating !



- 3、 After the program runs, automatic Alarm (8 SECONDS) , and automatically cut off the heating power, this time you can check the following solder ball is completely liquefied, BGA chips should be subject to settlement, floating state .

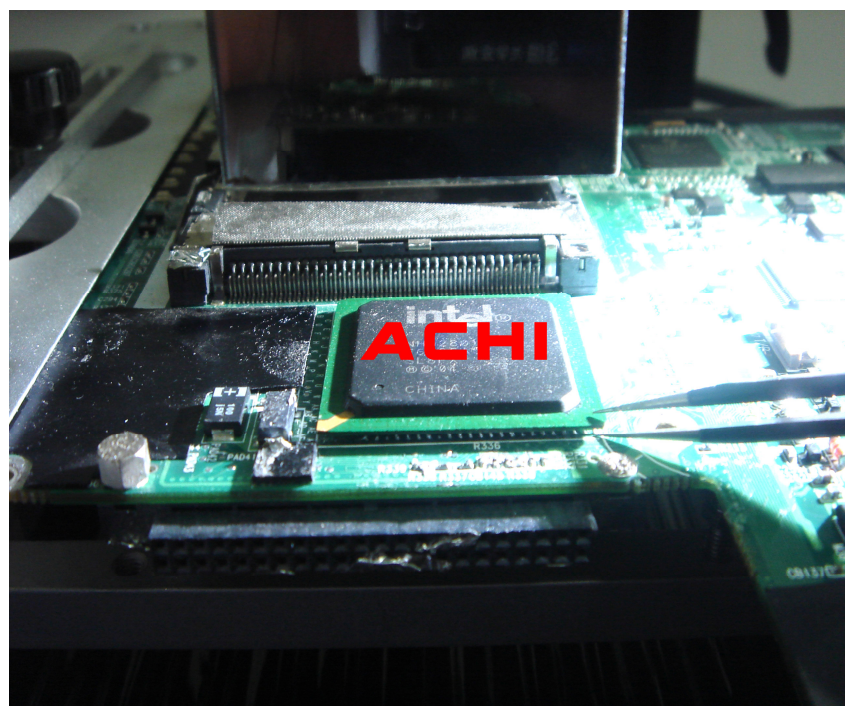

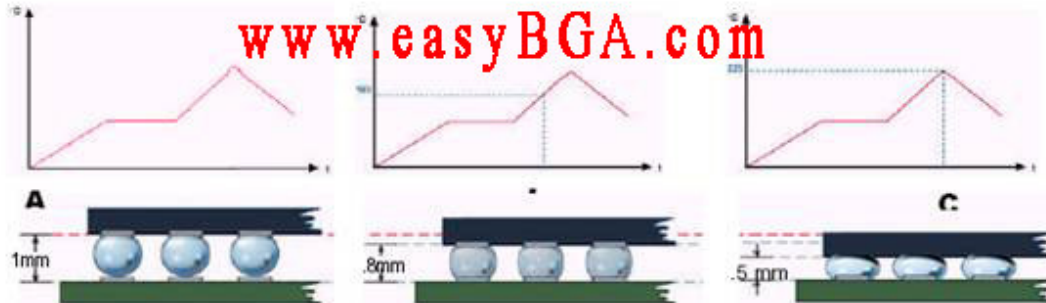

### 3、Heating completed

- 1、 Moving Heating head and Sensor ,open the Upper fan and Cooling Fan Switch
- 2、 Remove motherboard , Clear insulating tape !
- 3、 BGA Rework Station Cooled ,Then close Total Power !

#### **Warning:**

- If BGA Rework Station NO Cooling , Do not close the Power !
- When the temperature is not cooled, Do not touch heating module!

## Prompt

- 1、 Installed the equipment in stable work platform to use where the air mobility should be small as possible .Avoid it closing to air conditioners, fans and the other outlet.
- 2、 **ACHI® IR-PRO-SC** Rework Station sensor Direct contact with motherboard, So Temperature display is Actual temperature。
- 3、 In order to avoid damage to the motherboard capacitor, so use insulation tape please , Maintenance completed ,then Removal of insulation tape , So as to avoid short-circuit!
- 4、 After removal of BGA chip , PCB Bonding Pad Need to clean up , Avoid cold solder joint See BGA chip tin completely liquefied, Then To move the BGA chip, So as to avoid Bonding Pad Damage !
- 5、 BGA chips should be subject to settlement, floating state Prohibited in all solder ball did not fully liquefied, by force if removal of chips, so as to avoid pad off, chip or motherboard scrap!
- 6、 To improve success rate of Rework , PCB and chips need drying and processing in principle, PCB board or chip moist heat process will occur in the burst phenomenon, the Rework process may hear the blasting sound of a minor。 According to actual situation Please, self-control.
- 7、 PCB board heating time is too long or repeated several times the surface heating will lead to discoloration.
- 8、 Users from modifying temperature parameters, Please use scrap PCB tested, Heating whole time about 10 seconds before the end of solder balls should be fully liquefied, f the liquefaction advanced or delayed, ! Should be regulating up/down the temperature setting. So as to avoid heat damage to chips or low-temperature sealing-off。
- 9、 The factory equipped with two sets of programmable temperature control table used parameters:

**PTN-1: Lead Rework**

**PTN-2: Lead-Free Rework**

Rework temperature curve to set examples					
Lead : Sn63Pb37					
PTN- 1					
r1	1	L1	85	d1	80
r2	1	L2	150	d2	55
r3	1	L3	185	d3	45
r4	END				
Lead-Free:					
Sn96.5Ag3Cu0.5					
PTN- 2					
r1	1	L1	85	d1	60
r2	1	L2	140	d2	45
r3	1	L3	170	d3	35
r4	1	L4	220	d4	40
r5	END				



**1/The meaning of ‘Hb’:**

“Hb” means the max heating temperature of the upper heating. We set the max temperature at 230°C according to the max temperature of lead-free Rework and other technical reasons. **The data needn’t to be changed.**

**2/The meaning of “r1” “L1” “d1” “r2” “L2” “d2” “r3” “L3” “d3” .....**

Please pay attention to The following pictures and tables:

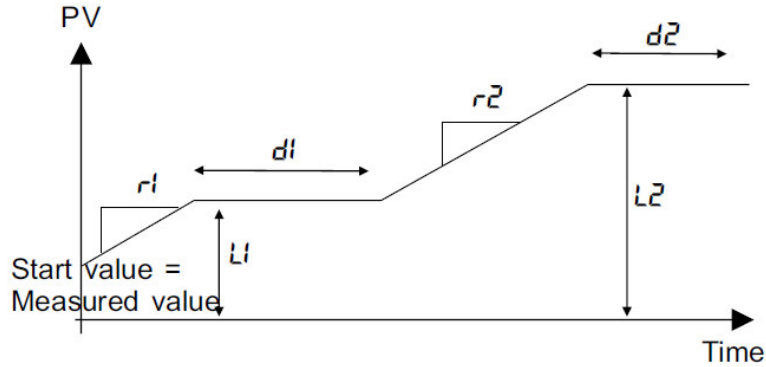

S.N.	Mnemonic	Parameter	Adjustable Range
1	<b>r1</b>	Ramp Rate 1	1
2	<b>L1</b>	Target Setpoint 1	0~230、End
3	<b>d1</b>	Dwell Time 1	0~9999sec
4	<b>r2</b>	Ramp Rate 2	1
5	<b>L2</b>	Target Setpoint 2	0~230、 <b>End</b>
6	<b>d2</b>	Dwell Time 2	0~9999sec
7	<b>r3</b>	Ramp Rate 2	1
8	<b>L3</b>	Target Setpoint 2	0~230、 <b>End</b>
9	<b>d3</b>	Dwell Time 2	0~9999sec
...	...	...	...
	<b>Hb</b>		<b>230</b>

<b>Rework temperature curve to set examples</b>					
<b>Lead Sn63Pb37</b>					
<b>PTN- 1</b>					
r1	1	L1	85	d1	70
r2	1	L2	150	d2	35
r3	1	L3	185	d3	50
r4	<b>END</b>	<b>Hb</b>	<b>230</b>		
<b>Lead-Free</b>					
<b>Sn96.5Ag3Cu0.5</b>					
<b>PTN- 2</b>					
r1	1	L1	85	d1	60
r2	1	L2	140	d2	45
r3	1	L3	170	d3	25
r4	1	L4	220	d4	50
r5	<b>END</b>	<b>Hb</b>	<b>230</b>		

3/ Please check Rework station surrounding environment, as far as possible away from the air outlet and other sources.

4/ Do not open upper fan in the welding process,

5/ Just remember that:

The max temperature of lead rework is approximately 183 °C,  
(Reflow temp:185°C~190°C , Reflow time: 10 Sec)

that of lead free is approximately 217 °C.  
(Reflow temp:220°C~225°C Reflow time: 15 Sec)

6/ No matter you click "Run" in the IRSOFT or Push the “start switch” on the control board , Rework station will be autorun current program segment in the Temperature Controller!

So you must Select the appropriate temperature program segment in the “PTN ”windows, or You can downloaded IRSOFT’data to the controller, covered, then run.

